

**1. Part Number:** A196-20

**2. Photograph:**

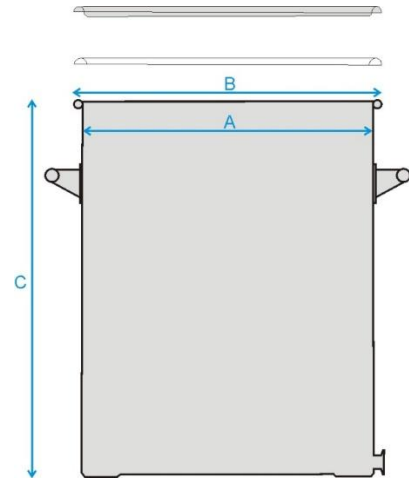

**3. Product Information:**

Description	Stainless Storage Drum 20L with 1" Ferrule
Materials of Construction:	<ul style="list-style-type: none"> <li>- Body: 316L stainless steel</li> <li>- Ferrule: 316L stainless steel</li> <li>- Lid: 316L stainless steel</li> <li>- Clamp: 304 stainless steel</li> <li>- Handles: 304 stainless steel</li> <li>- Gasket: Silicone (FDA 177.2600 and USP Class VI compliant)</li> </ul>
Nominal Volume:	20 Litres
Method of Construction:	Welds ground and polished
Surface Finish:	Better than 0.5 microns Ra
Dimensions	A = 300 mm B = 320 mm C = 310 mm
Graduation Marks:	None
Ferrule:	1" (to standard BS4825-3)
Ferrule location	22mm (approx.) from base to underside of ferrule
Handles:	2 side handles welded onto patch plates
Weight:	5.6 Kg (body + gasket + lid + clamp)
BSE/TSE statement:	All polishing compounds used in the manufacture of this product are of vegetable origin
Recommended Storage Conditions:	Dry and ambient temperature
Note:	This product should be thoroughly cleaned before it is used for the first time

**4. Approval:**

Signed:



Name: Kuldeep Flora

Position: Quality Manager

Date: 18-Dec-24