

1. Part Number: A196-15

2. Photograph:

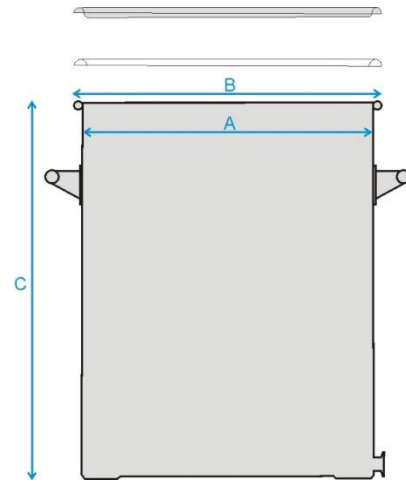

3. Product Information:

Description	Stainless Storage Drum 15L with 1" Ferrule
Materials of Construction:	<ul style="list-style-type: none"> - Body: 316L stainless steel - Ferrule: 316L stainless steel - Lid: 316L stainless steel - Clamp: 304 stainless steel - Handles: 304 stainless steel - Gasket: Silicone (FDA 177.2600 and USP Class VI compliant)
Nominal Volume:	15 Litres
Method of Construction:	Welds ground and polished
Surface Finish:	Better than 0.5 microns Ra
Dimensions	A = 230 mm B = 250 mm C = 380 mm
Graduation Marks:	None
Ferrule:	1" (to standard BS4825-3)
Ferrule location	22mm (approx.) from base to underside of ferrule
Handles:	2 side handles welded onto patch plates
Weight:	5.5 Kg (body + gasket + lid + clamp)
BSE/TSE statement:	All polishing compounds used in the manufacture of this product are of vegetable origin
Recommended Storage Conditions:	Dry and ambient temperature
Note: This product should be thoroughly cleaned before it is used for the first time	

4. Approval:

Signed:



Name: Kuldeep Flora

Position: Quality Manager

Date: 18-Dec-24